

WESTINGHOUSE
Chassis V-2515-11
Models H-M1780, A,
H-M1781, H-M1783

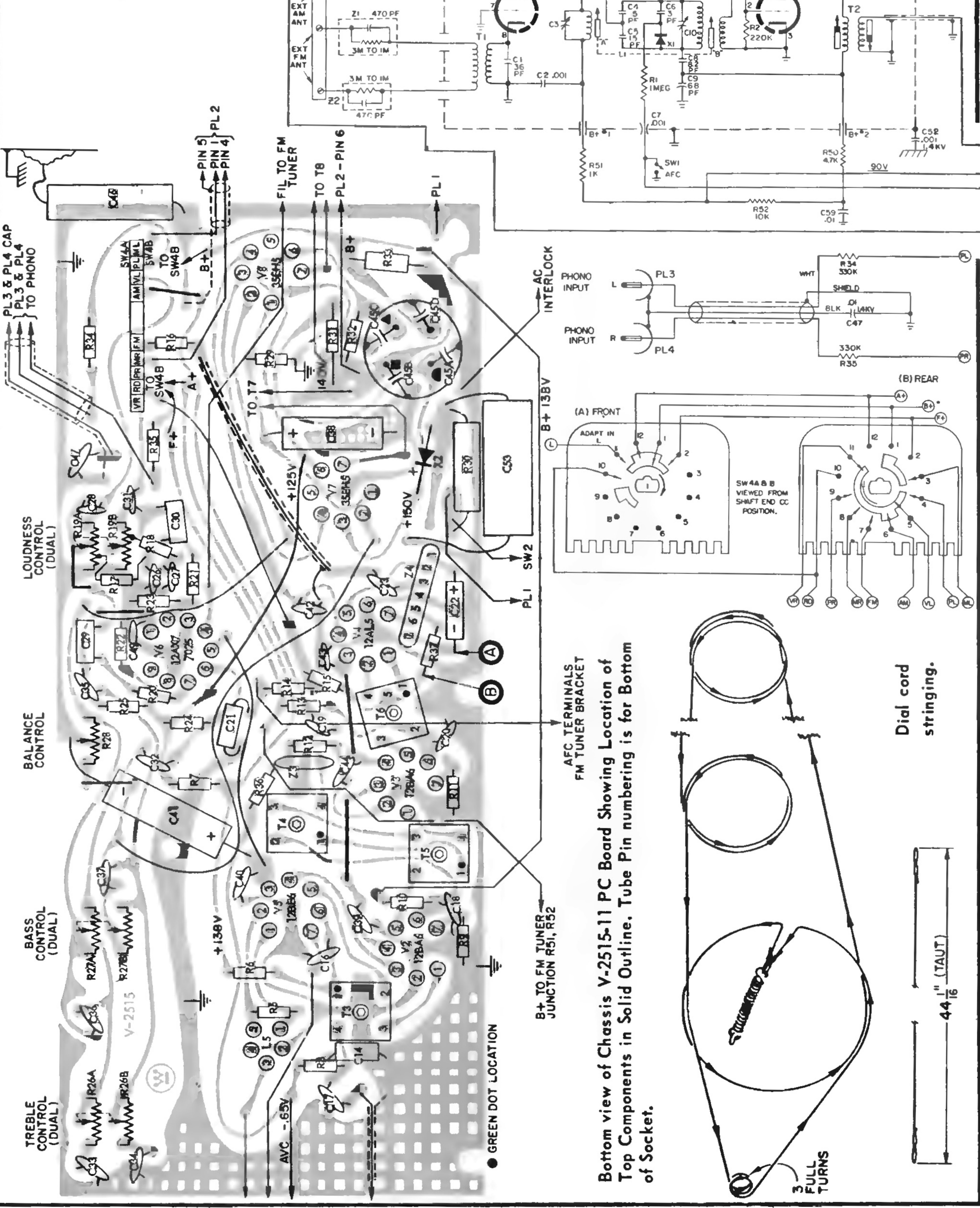

Bottom view of Chassis V-2515-11 PC Board showing Location of Top Components in Solid Outline. Tube Pin numbering is for Bottom of Socket.

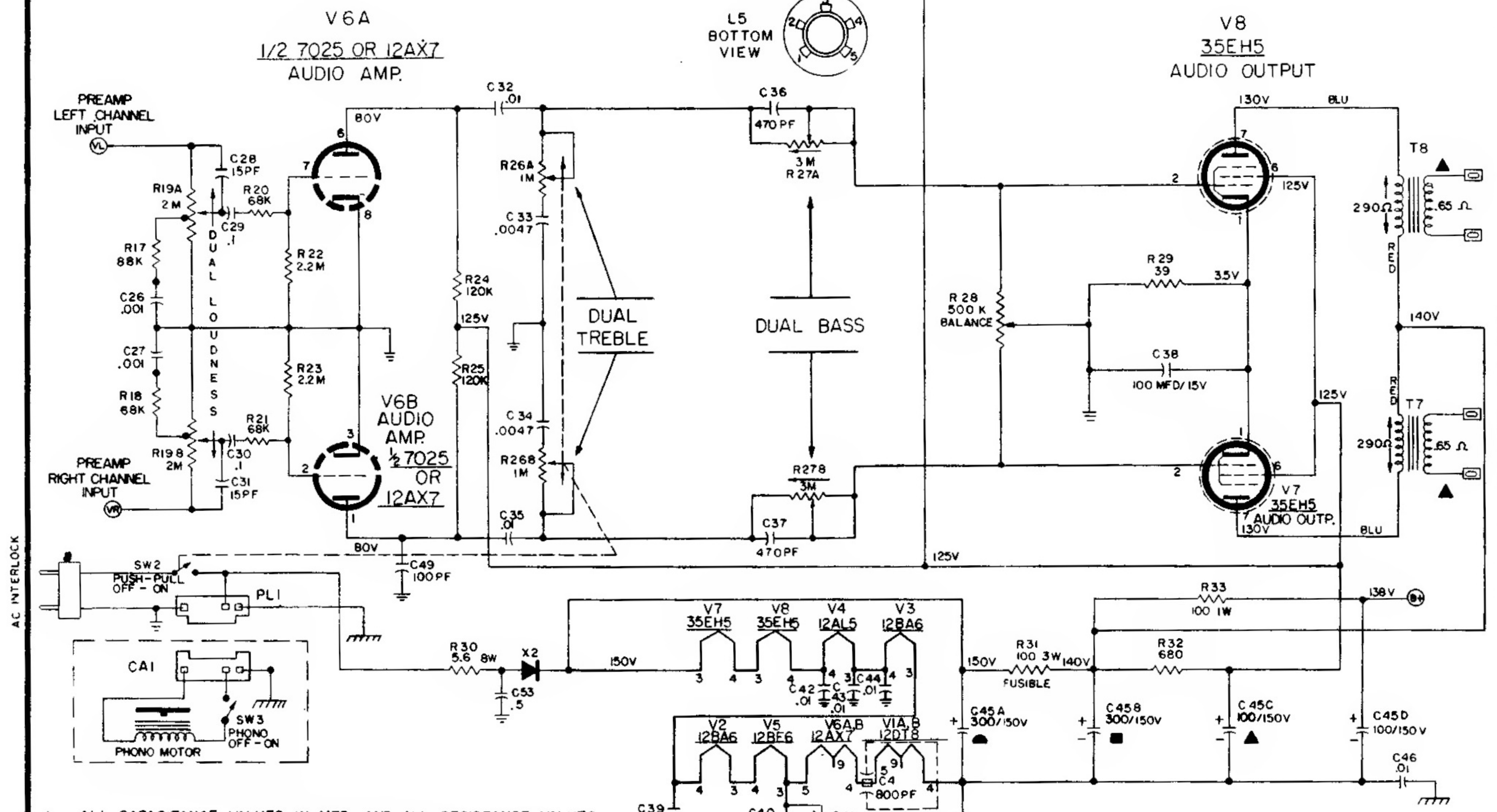
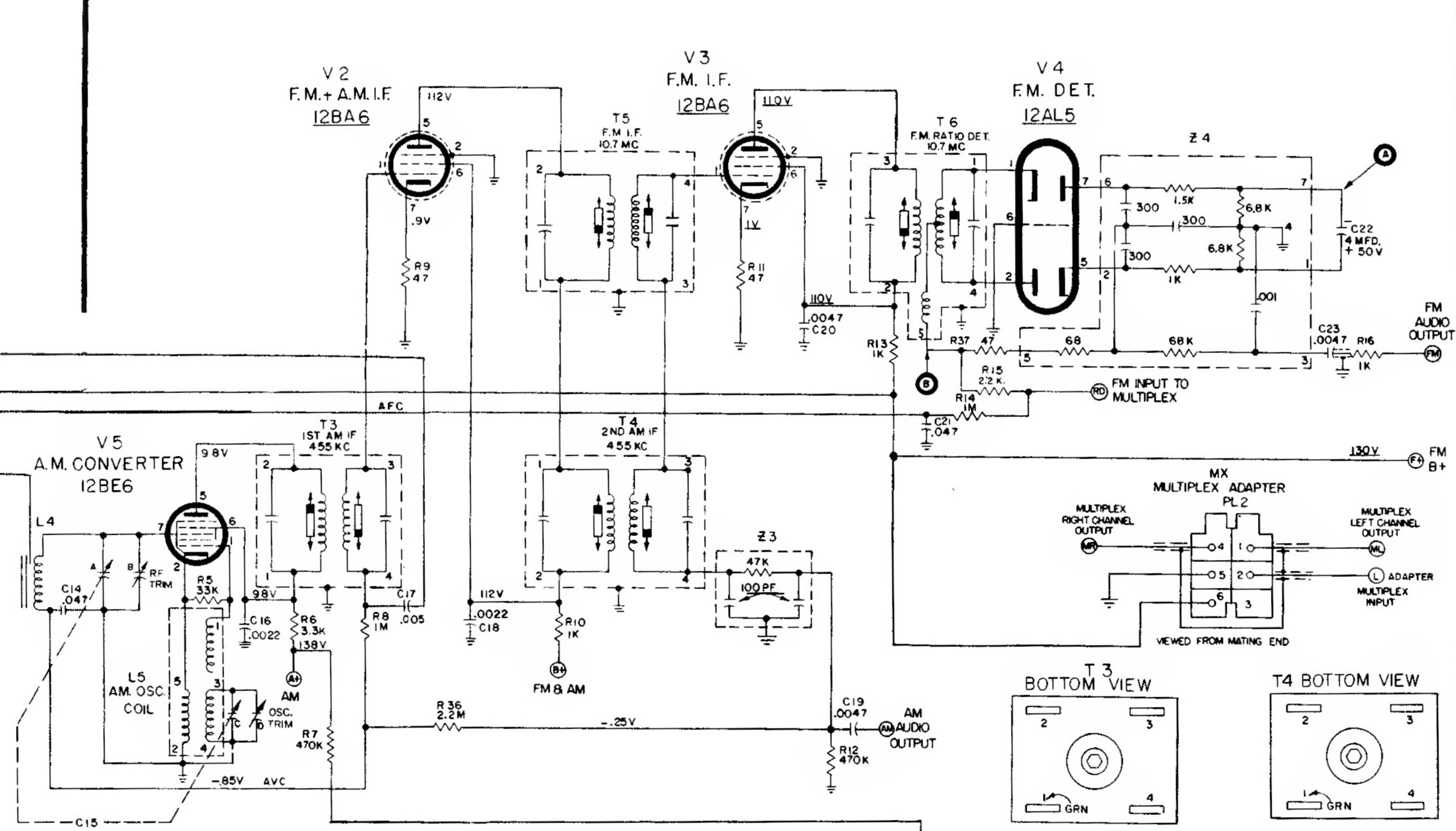
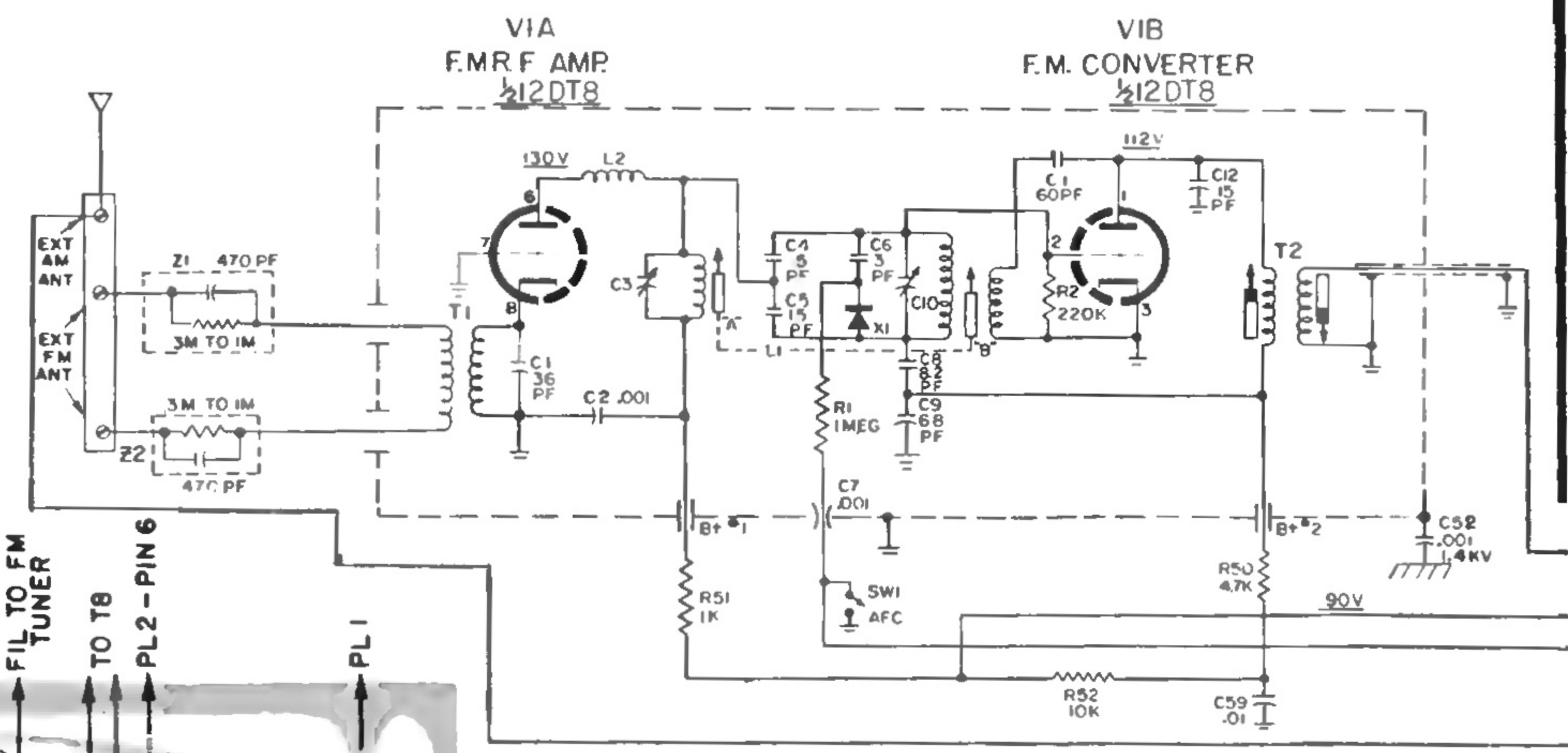
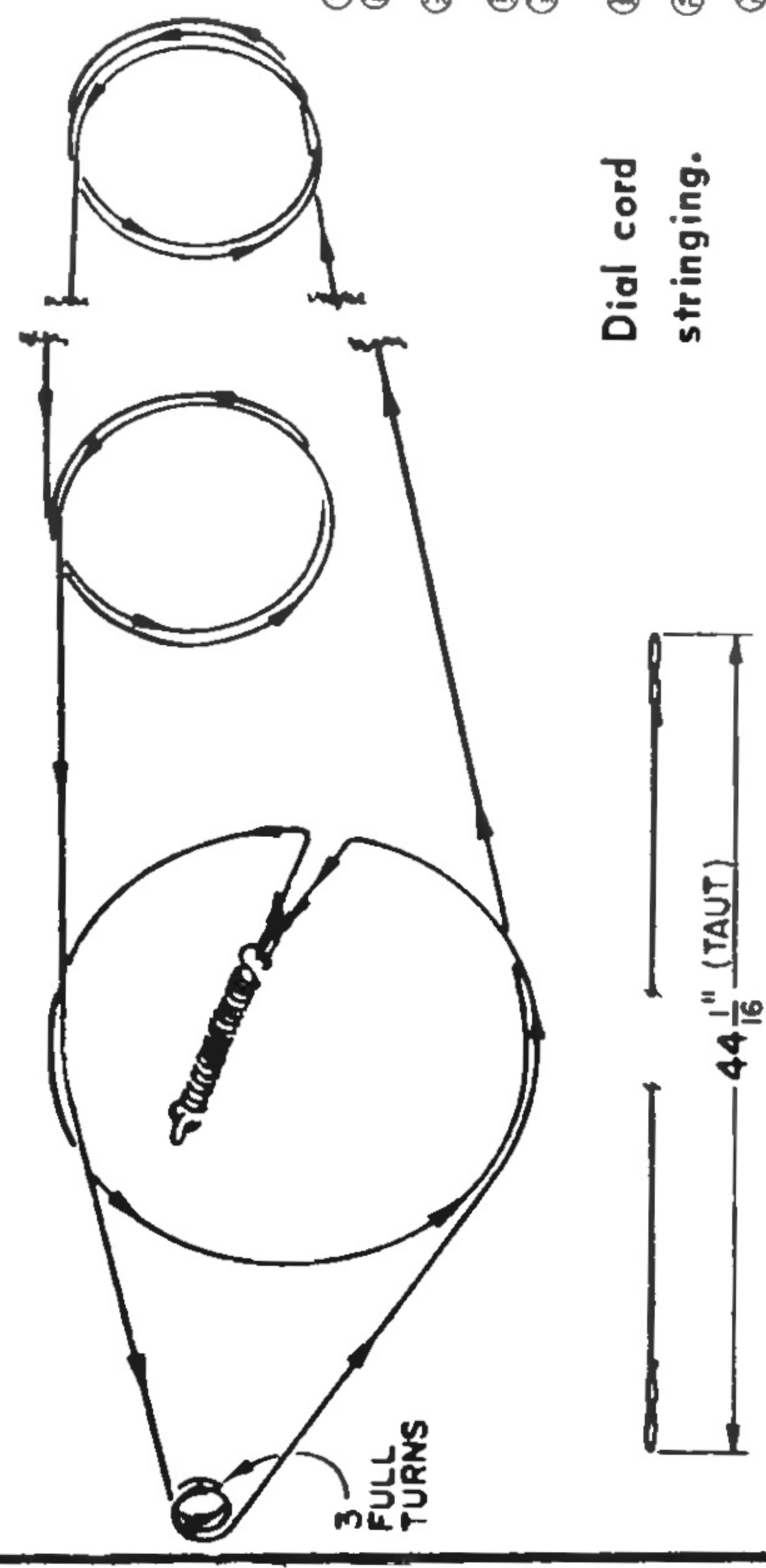

1. ALL CAPACITANCE VALUES IN MED. AND ALL RESISTANCE VALUES IN DHMS, 1/2 WATT; UNLESS OTHERWISE SPECIFIED.
2. D.C. VOLTAGES MEASURED FROM POINTS INDICATED TO CIRCUIT GROUND - NO SIGNAL APPLIED, USING A V.T.V.M. LINE VOLTAGE SET AT 120 V A.C. NO SIGNAL INPUT LOUDNESS AT MIN, TO TUNING CAPC. AT MAX.
3. UNDERLINED VOLTAGES ARE TAKEN IN FM POSITION.
4. SW4A AND B IS SHOWN IN THE CCW POSITION. (AM. POSITION)
5. ALL REFERENCES TO LEFT AND RIGHT ARE AS VIEWED FRONT OF SET.
6. REAR SECTIONS OF CONTROLS (FARTHEST FROM SHAFTS) ARE RIGHT CHANNEL.
7. ARROWS DN CONTROLS INDICATE CW ROTATION (CONTROL VIEWED FROM SHAFT END.)

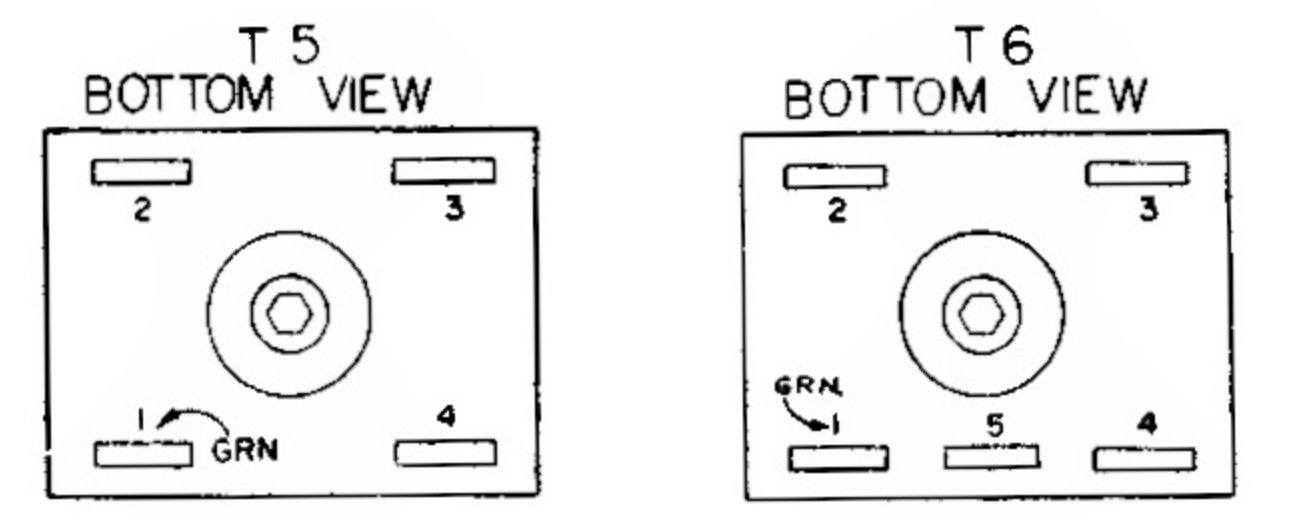
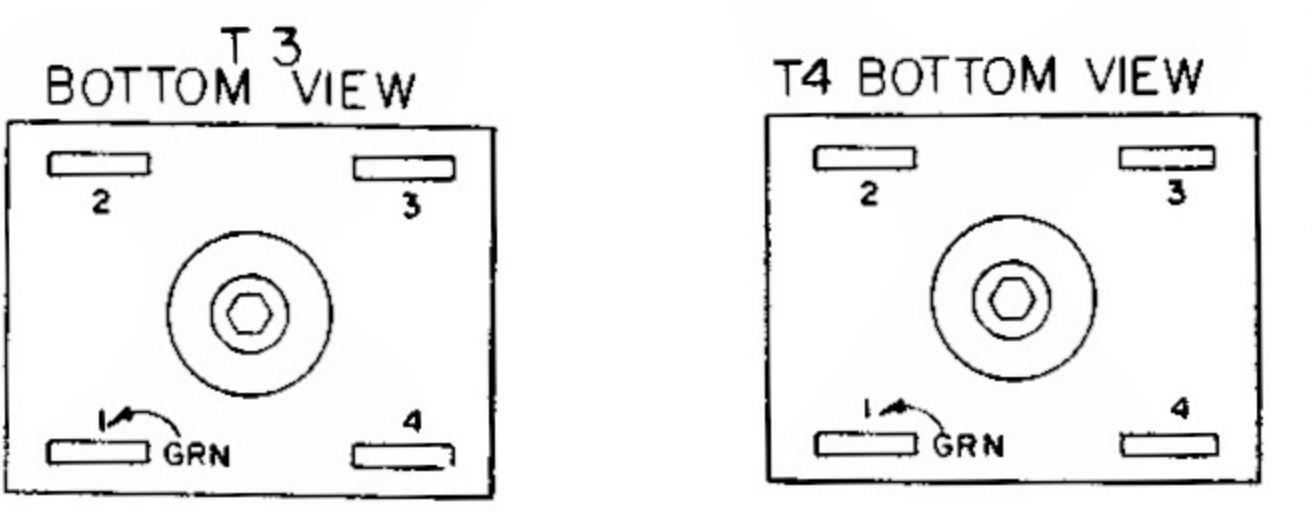

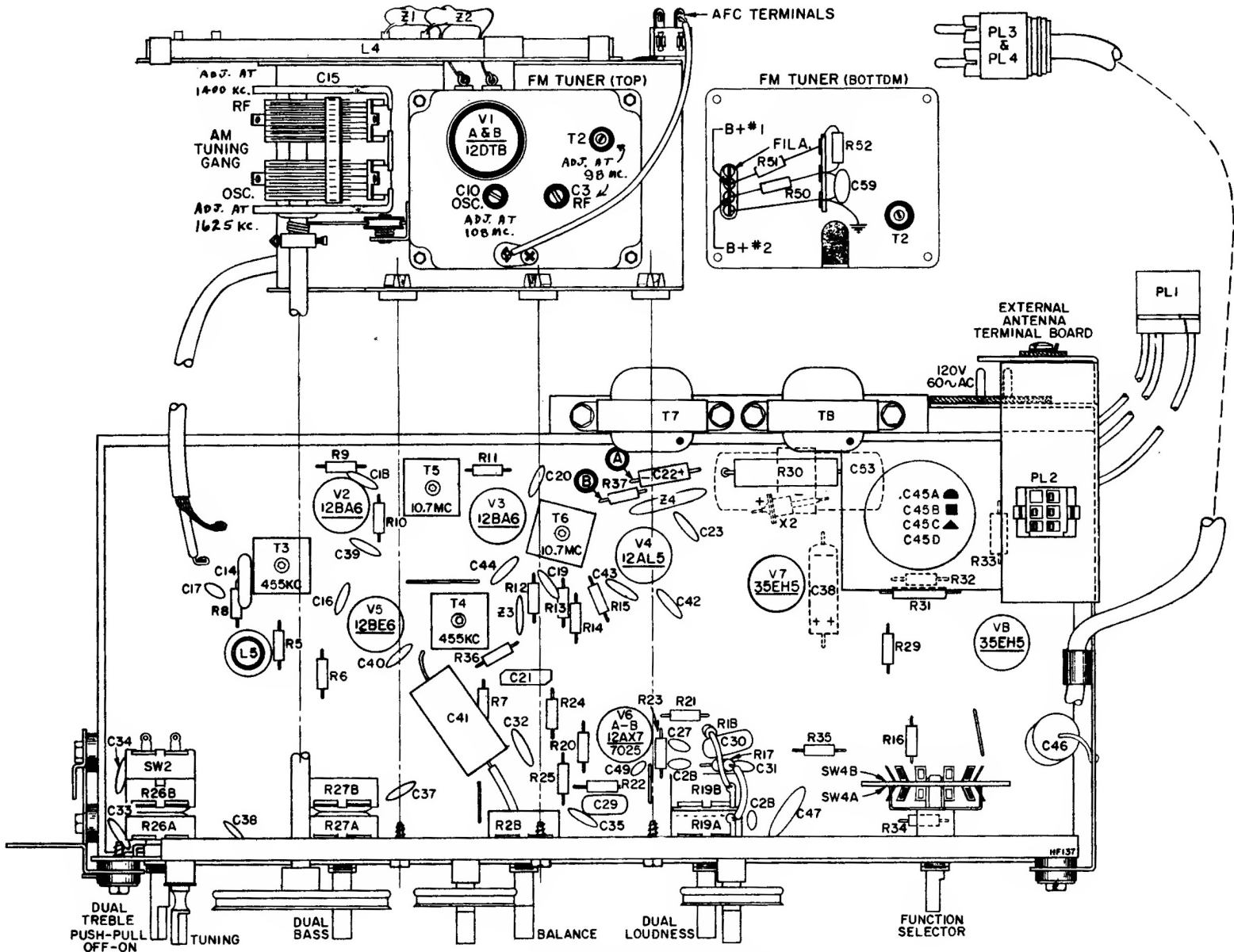

Top View of V-2515-11 Chassis